

# GSS4565

## N AND P-CHANNEL ENHANCEMENT MODE POWER MOSFET

N-CH BV <sub>DSS</sub>	40V
R <sub>DS(ON)</sub>	25mΩ
I <sub>D</sub>	7.6A
P-CH BV <sub>DSS</sub>	-40V
R <sub>DS(ON)</sub>	33mΩ
I <sub>D</sub>	-6.5A

### Description

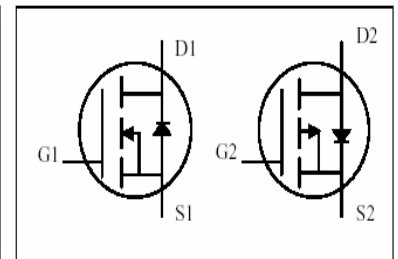
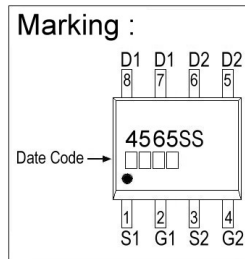
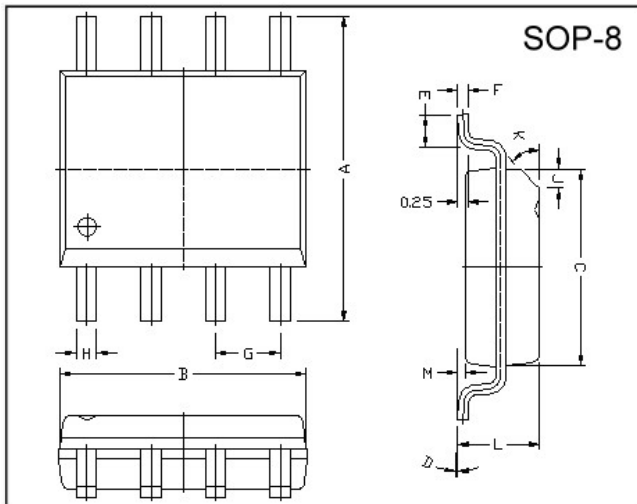
The GSS4565 provide the designer with the best combination of fast switching, ruggedized device design, low on-resistance and cost-effectiveness.

The SOP-8 package is universally preferred for all commercial-industrial surface mount applications and suited for low voltage applications such as DC/DC converters.

### Features

- \*Simple Drive Requirement
- \*Lower On-resistance
- \*Fast Switching Performance

### Package Dimensions



REF.	Millimeter		REF.	Millimeter	
	Min.	Max.		Min.	Max.
A	5.80	6.20	M	0.10	0.25
B	4.80	5.00	H	0.35	0.49
C	3.80	4.00	L	1.35	1.75
D	0°	8°	J	0.375 REF.	
E	0.40	0.90	K	45°	
F	0.19	0.25	G	1.27 TYP.	

### Absolute Maximum Ratings

Parameter	Symbol	Ratings		Unit
		N-channel	P-channel	
Drain-Source Voltage	V <sub>DS</sub>	40	-40	V
Gate-Source Voltage	V <sub>GS</sub>	±20	±20	V
Continuous Drain Current <sup>3</sup>	I <sub>D</sub> @TA=25°C	7.6	-6.5	A
Continuous Drain Current <sup>3</sup>	I <sub>D</sub> @TA=70°C	6	-5.2	A
Pulsed Drain Current <sup>1</sup>	I <sub>DM</sub>	30	-30	A
Total Power Dissipation	P <sub>D</sub> @TA=25°C	2.0		W
Linear Derating Factor		0.016		W/°C
Operating Junction and Storage Temperature Range	T <sub>j</sub> , T <sub>stg</sub>	-55 ~ +150		°C

### Thermal Data

Parameter	Symbol	Value	Unit
Thermal Resistance Junction-ambient <sup>3</sup> Max.	R <sub>thj-a</sub>	62.5	°C/W

**N-Channel Electrical Characteristics(T<sub>j</sub> = 25°C Unless otherwise specified)**

Parameter	Symbol	Min.	Typ.	Max.	Unit	Test Conditions
Drain-Source Breakdown Voltage	$BV_{DSS}$	40	-	-	V	$V_{GS}=0, I_D=250\mu A$
Breakdown Voltage Temperature Coefficient	$\Delta BV_{DSS} / \Delta T_j$	-	0.03	-	V/°C	Reference to 25°C, $I_D=1mA$
Gate Threshold Voltage	$V_{GS(th)}$	1.0	-	3.0	V	$V_{DS}=V_{GS}, I_D=250\mu A$
Forward Transconductance	$g_{fs}$	-	12	-	S	$V_{DS}=10V, I_D=7A$
Gate-Source Leakage Current	$I_{GSS}$	-	-	±100	nA	$V_{GS}= \pm 20V$
Drain-Source Leakage Current(T <sub>j</sub> =25°C)	$I_{DSS}$	-	-	1	uA	$V_{DS}=40V, V_{GS}=0$
Drain-Source Leakage Current(T <sub>j</sub> =70°C)		-	-	25	uA	$V_{DS}=32V, V_{GS}=0$
Static Drain-Source On-Resistance <sup>2</sup>	$R_{DS(ON)}$	-	-	25	mΩ	$V_{GS}=10V, I_D=7A$
		-	-	32		$V_{GS}=4.5V, I_D=5A$
Total Gate Charge <sup>2</sup>	$Q_g$	-	17	27	nC	$I_D=7A$ $V_{DS}=32V$ $V_{GS}=4.5V$
Gate-Source Charge	$Q_{gs}$	-	4	-		
Gate-Drain ("Miller") Charge	$Q_{gd}$	-	10	-		
Turn-on Delay Time <sup>2</sup>	$T_{d(on)}$	-	11	-	ns	$V_{DS}=20V$ $I_D=1A$ $V_{GS}=10V$ $R_G=3.3\Omega$ $R_D=20\Omega$
Rise Time	$T_r$	-	8	-		
Turn-off Delay Time	$T_{d(off)}$	-	30	-		
Fall Time	$T_f$	-	11	-		
Input Capacitance	$C_{iss}$	-	1400	2240	pF	$V_{GS}=0V$ $V_{DS}=25V$ $f=1.0MHz$
Output Capacitance	$C_{oss}$	-	250	-		
Reverse Transfer Capacitance	$C_{rss}$	-	170	-		

**Source-Drain Diode**

Parameter	Symbol	Min.	Typ.	Max.	Unit	Test Conditions
Forward On Voltage <sup>2</sup>	$V_{SD}$	-	-	1.2	V	$I_S=1.7A, V_{GS}=0V, T_j=25^\circ C$
Reverse Recovery Time <sup>2</sup>	$T_{rr}$	-	26	-	ns	$I_S=7A, V_{GS}=0V$ $di/dt=100A/\mu s$
Reverse Recovery Charge	$Q_{rr}$	-	21	-	nC	

Notes: 1. Pulse width limited by Max. junction temperature.

2. Pulse width  $\leq 300\mu s$ , duty cycle  $\leq 2\%$ .

3. Surface mounted on 1 in<sup>2</sup> copper pad of FR4 board; 135°C/W when mounted on Min. copper pad.

**P-Channel Electrical Characteristics(T<sub>j</sub> = 25°C Unless otherwise specified)**

Parameter	Symbol	Min.	Typ.	Max.	Unit	Test Conditions
Drain-Source Breakdown Voltage	BV <sub>DSS</sub>	-40	-	-	V	V <sub>GS</sub> =0, I <sub>D</sub> =-250uA
Breakdown Voltage Temperature Coefficient	$\Delta BV_{DSS} / \Delta T_j$	-	-0.03	-	V/°C	Reference to 25°C, I <sub>D</sub> =-1mA
Gate Threshold Voltage	V <sub>GS(th)</sub>	-1.0	-	-3.0	V	V <sub>DS</sub> =V <sub>GS</sub> , I <sub>D</sub> =-250uA
Forward Transconductance	g <sub>fs</sub>	-	10	-	S	V <sub>DS</sub> =-10V, I <sub>D</sub> =-6A
Gate-Source Leakage Current	I <sub>GSS</sub>	-	-	±100	nA	V <sub>GS</sub> = ±20V
Drain-Source Leakage Current(T <sub>j</sub> =25°C)	I <sub>DSS</sub>	-	-	-1	uA	V <sub>DS</sub> =-40V, V <sub>GS</sub> =0
Drain-Source Leakage Current(T <sub>j</sub> =70°C)		-	-	-25	uA	V <sub>DS</sub> =-32V, V <sub>GS</sub> =0
Static Drain-Source On-Resistance <sup>2</sup>	R <sub>DS(ON)</sub>	-	-	33	mΩ	V <sub>GS</sub> =-10V, I <sub>D</sub> =-6A
		-	-	42		V <sub>GS</sub> =-4.5V, I <sub>D</sub> =-4A
Total Gate Charge <sup>2</sup>	Q <sub>g</sub>	-	20	32	nC	I <sub>D</sub> =-6A V <sub>DS</sub> =-32V V <sub>GS</sub> =-4.5V
Gate-Source Charge	Q <sub>gs</sub>	-	4	-		
Gate-Drain ("Miller") Change	Q <sub>gd</sub>	-	10	-		
Turn-on Delay Time <sup>2</sup>	T <sub>d(on)</sub>	-	11	-	ns	V <sub>DS</sub> =-20V I <sub>D</sub> =-1A V <sub>GS</sub> =-10V R <sub>G</sub> =3.3Ω R <sub>D</sub> =20Ω
Rise Time	T <sub>r</sub>	-	7	-		
Turn-off Delay Time	T <sub>d(off)</sub>	-	67	-		
Fall Time	T <sub>f</sub>	-	43	-		
Input Capacitance	C <sub>iss</sub>	-	1440	2300	pF	V <sub>GS</sub> =0V V <sub>DS</sub> =-25V f=1.0MHz
Output Capacitance	C <sub>oss</sub>	-	250	-		
Reverse Transfer Capacitance	C <sub>rss</sub>	-	190	-		

**Source-Drain Diode**

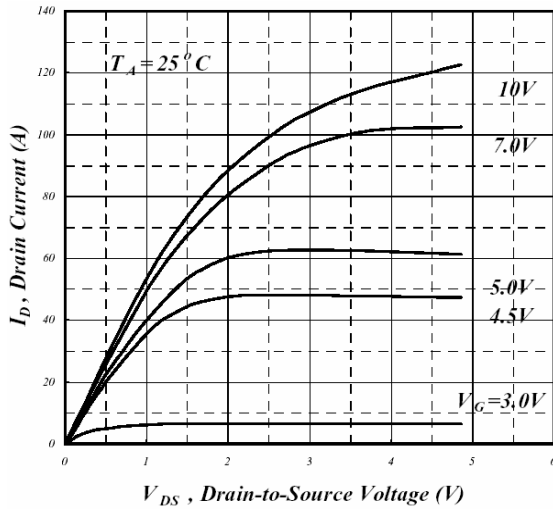
Parameter	Symbol	Min.	Typ.	Max.	Unit	Test Conditions
Forward On Voltage <sup>2</sup>	V <sub>SD</sub>	-	-	-1.2	V	I <sub>S</sub> =-1.7A, V <sub>GS</sub> =0V, T <sub>j</sub> =25°C
Reverse Recovery Time <sup>2</sup>	T <sub>rr</sub>	-	27	-	ns	I <sub>S</sub> =-6A, V <sub>GS</sub> =0V di/dt=100A/μs
Reverse Recovery Charge	Q <sub>rr</sub>	-	23	-	nC	

Notes: 1. Pulse width limited by Max. junction temperature.

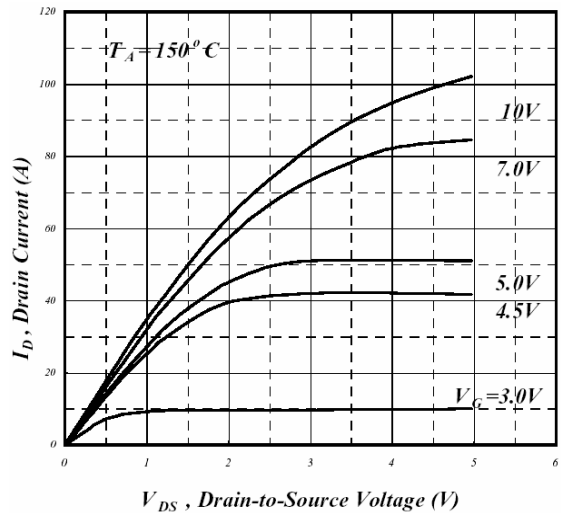
2. Pulse width ≤ 300us, duty cycle ≤ 2%.

3. Surface mounted on 1 in<sup>2</sup> copper pad of FR4 board; 135°C/W when mounted on Min. copper pad.

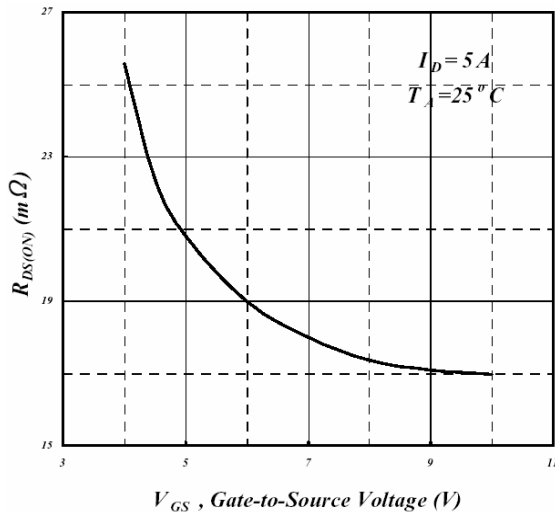
## Characteristics Curve N-Channel



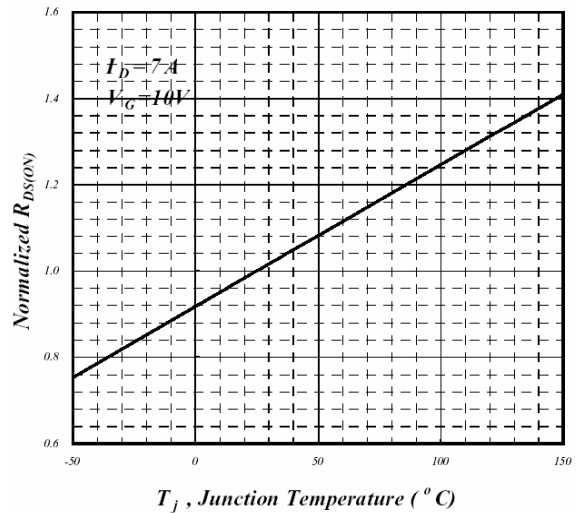
**Fig 1. Typical Output Characteristics**



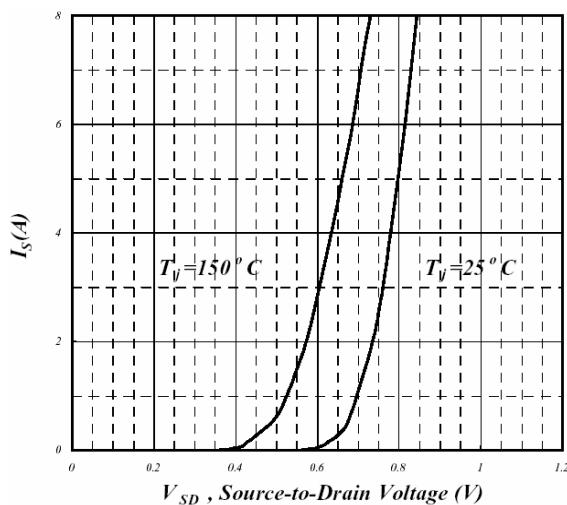
**Fig 2. Typical Output Characteristics**



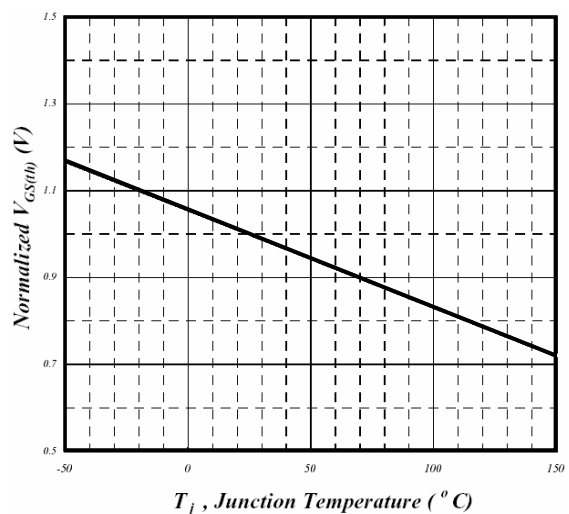
**Fig 3. On-Resistance v.s. Gate Voltage**



**Fig 4. Normalized On-Resistance v.s. Junction Temperature**

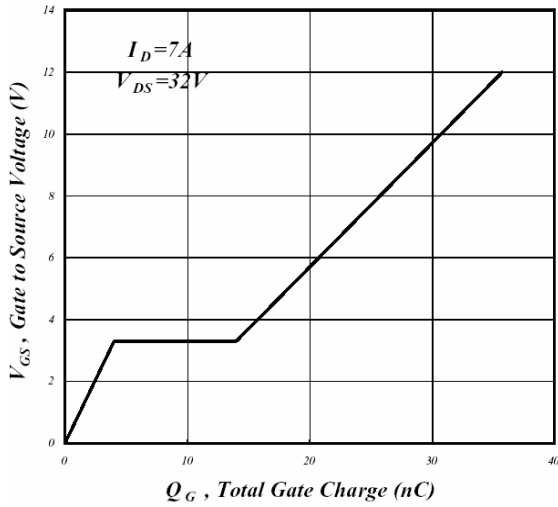


**Fig 5. Forward Characteristics of Reverse Diode**

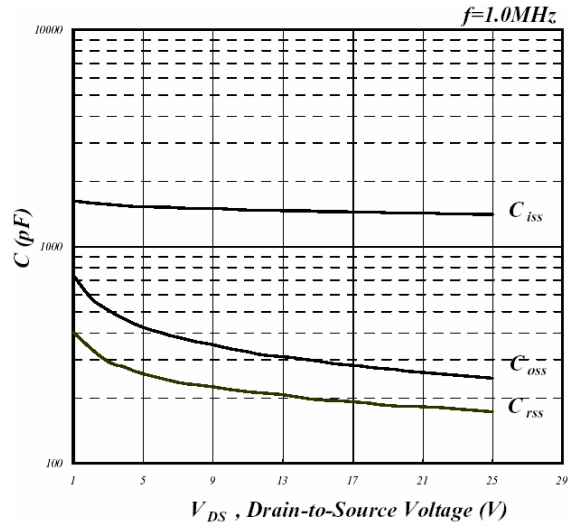


**Fig 6. Gate Threshold Voltage v.s. Junction Temperature**

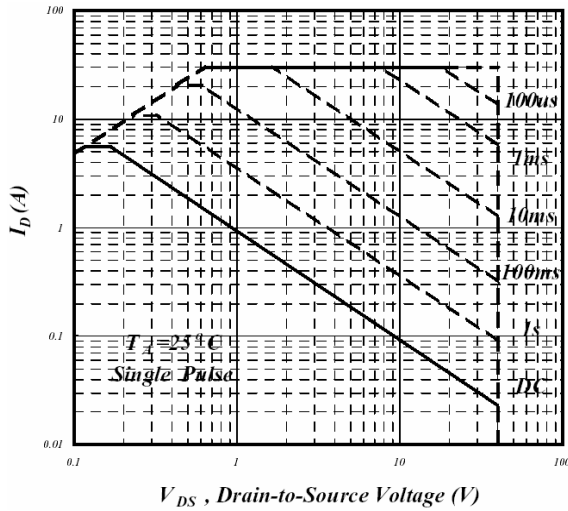
## N-Channel



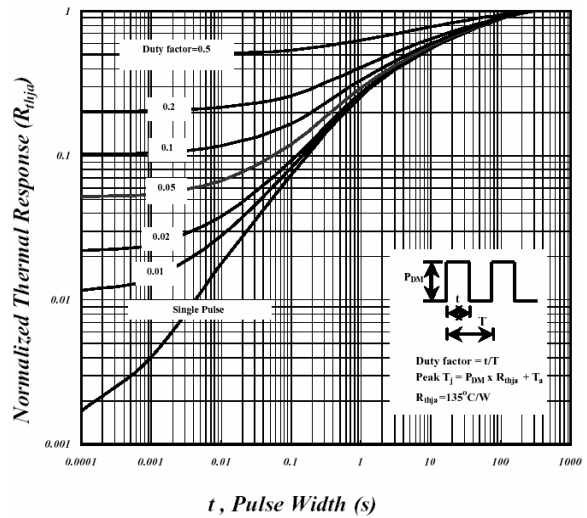
**Fig 7. Gate Charge Characteristics**



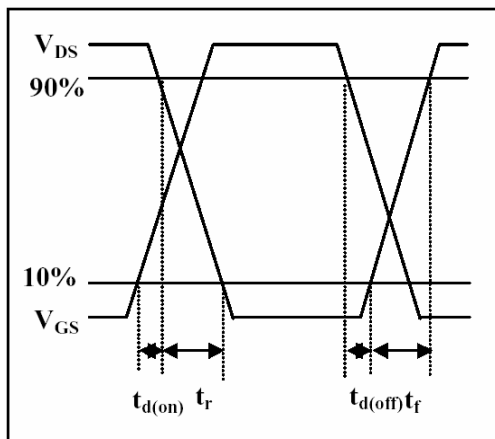
**Fig 8. Typical Capacitance Characteristics**



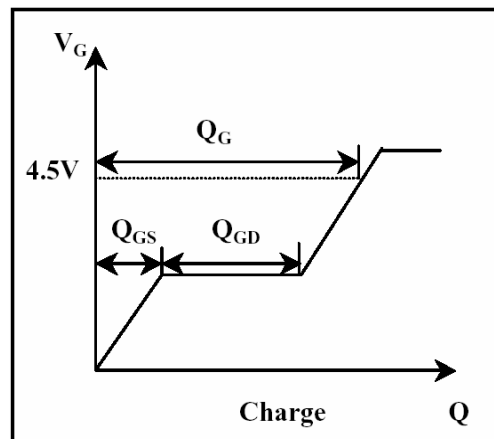
**Fig 9. Maximum Safe Operating Area**



**Fig 10. Effective Transient Thermal Impedance**

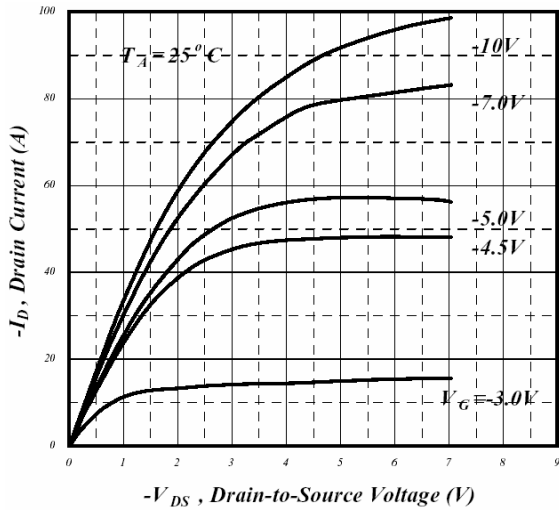


**Fig 11. Switching Time Waveform**

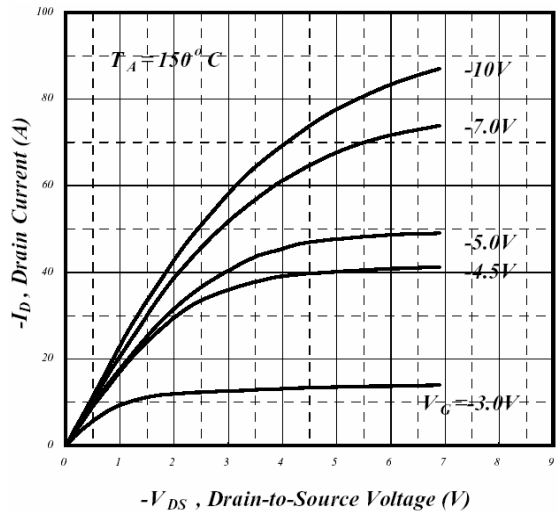


**Fig 12. Gate Charge Waveform**

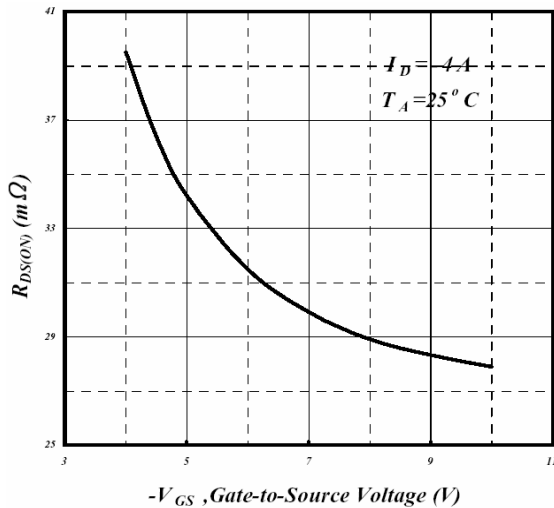
## P-Channel



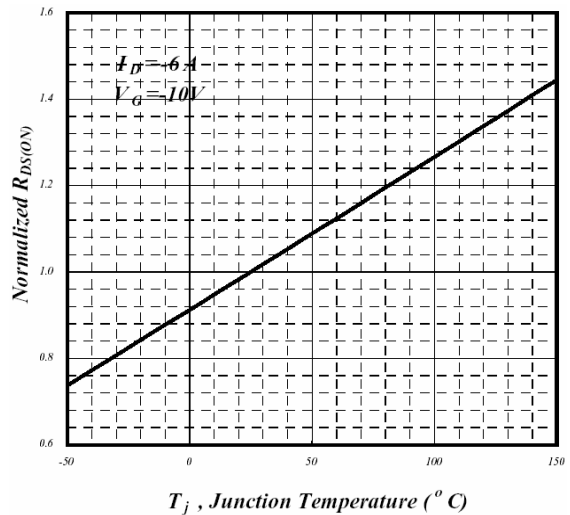
**Fig 1. Typical Output Characteristics**



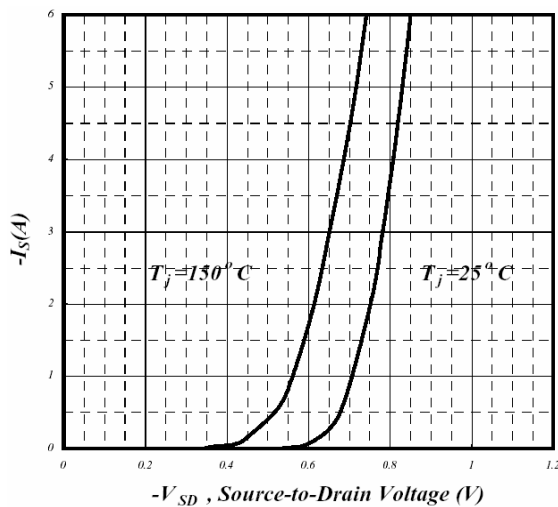
**Fig 2. Typical Output Characteristics**



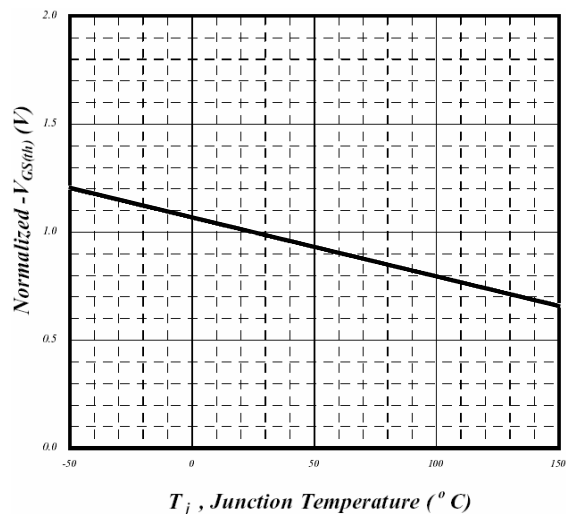
**Fig 3. On-Resistance v.s. Gate Voltage**



**Fig 4. Normalized On-Resistance v.s. Junction Temperature**

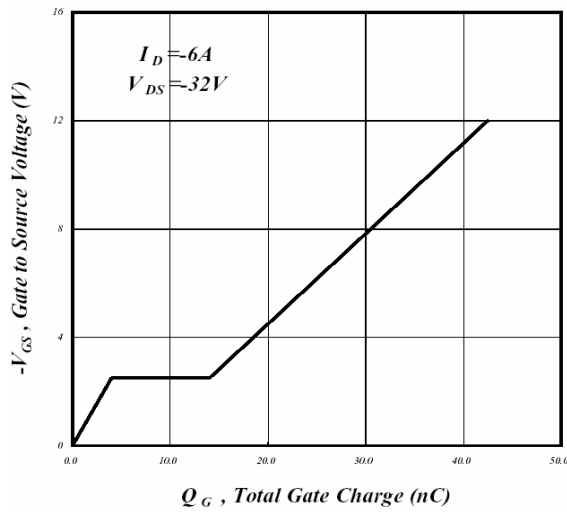


**Fig 5. Forward Characteristics of Reverse Diode**

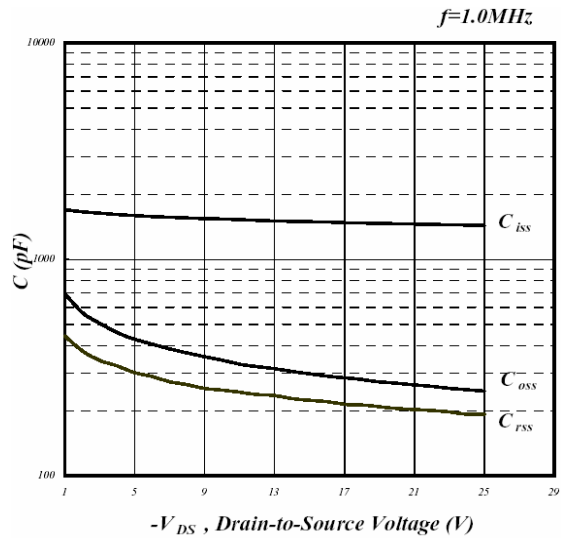


**Fig 6. Gate Threshold Voltage v.s. Junction Temperature**

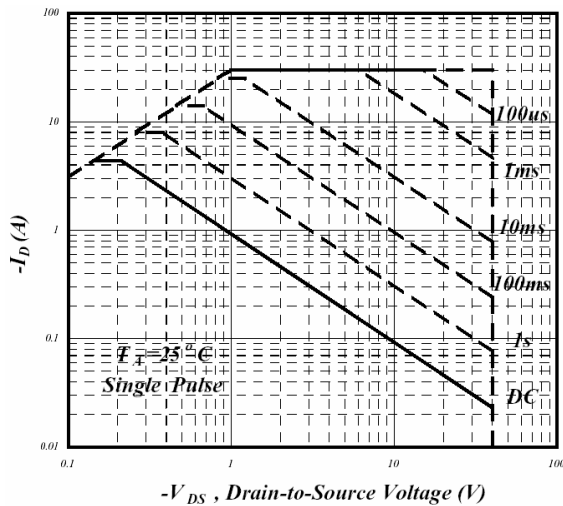
## P-Channel



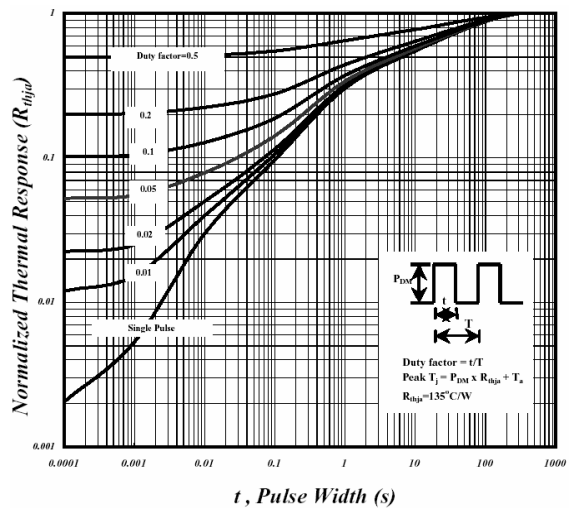
**Fig 7. Gate Charge Characteristics**



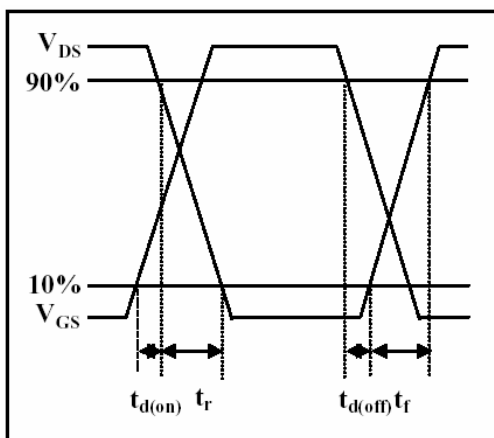
**Fig 8. Typical Capacitance Characteristics**



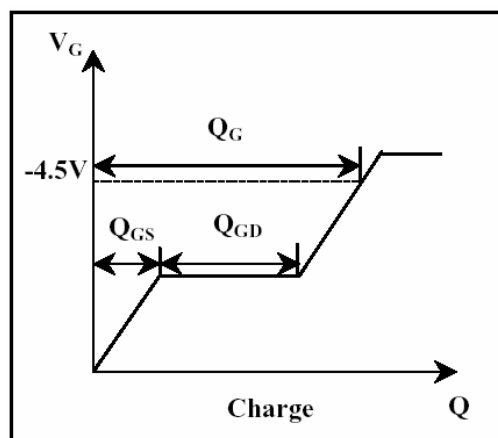
**Fig 9. Maximum Safe Operating Area**



**Fig 10. Effective Transient Thermal Impedance**



**Fig 11. Switching Time Waveform**



**Fig 12. Gate Charge Waveform**

**Important Notice:**

- All rights are reserved. Reproduction in whole or in part is prohibited without the prior written approval of GTM.
- GTM reserves the right to make changes to its products without notice.
- GTM semiconductor products are not warranted to be suitable for use in life-support Applications, or systems.
- GTM assumes no liability for any consequence of customer product design, infringement of patents, or application assistance.

**Head Office And Factory:**

- Taiwan:** No. 17-1 Tatung Rd. Fu Kou Hsin-Chu Industrial Park, Hsin-Chu, Taiwan, R. O. C.
- TEL : 886-3-597-7061 FAX : 886-3-597-9220, 597-0785
- China:** (201203) No.255, Jang-Jiang Tsai-Lueng RD. , Pu-Dung-Hsin District, Shang-Hai City, China
- TEL : 86-21-5895-7671 ~ 4 FAX : 86-21-38950165